

广州智光储能科技有限公司

GUANGZHOU ZHIGUANG ENERGY STORAGE TECHNOLOGY CO., LTD.



CONTENTS

— — —





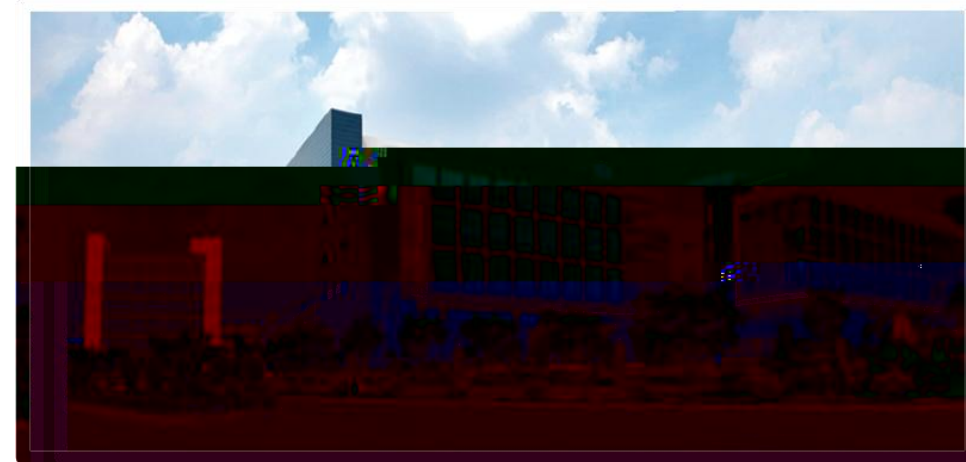
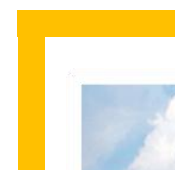

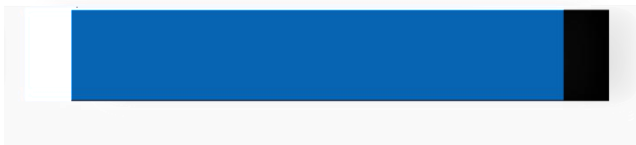



- ◆
- ◆
- ◆
- ◆
- ◆

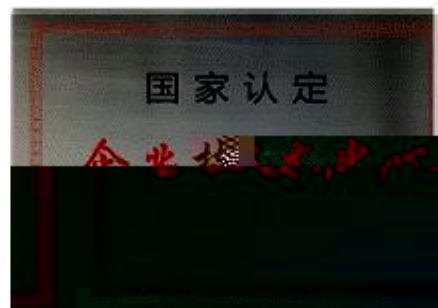

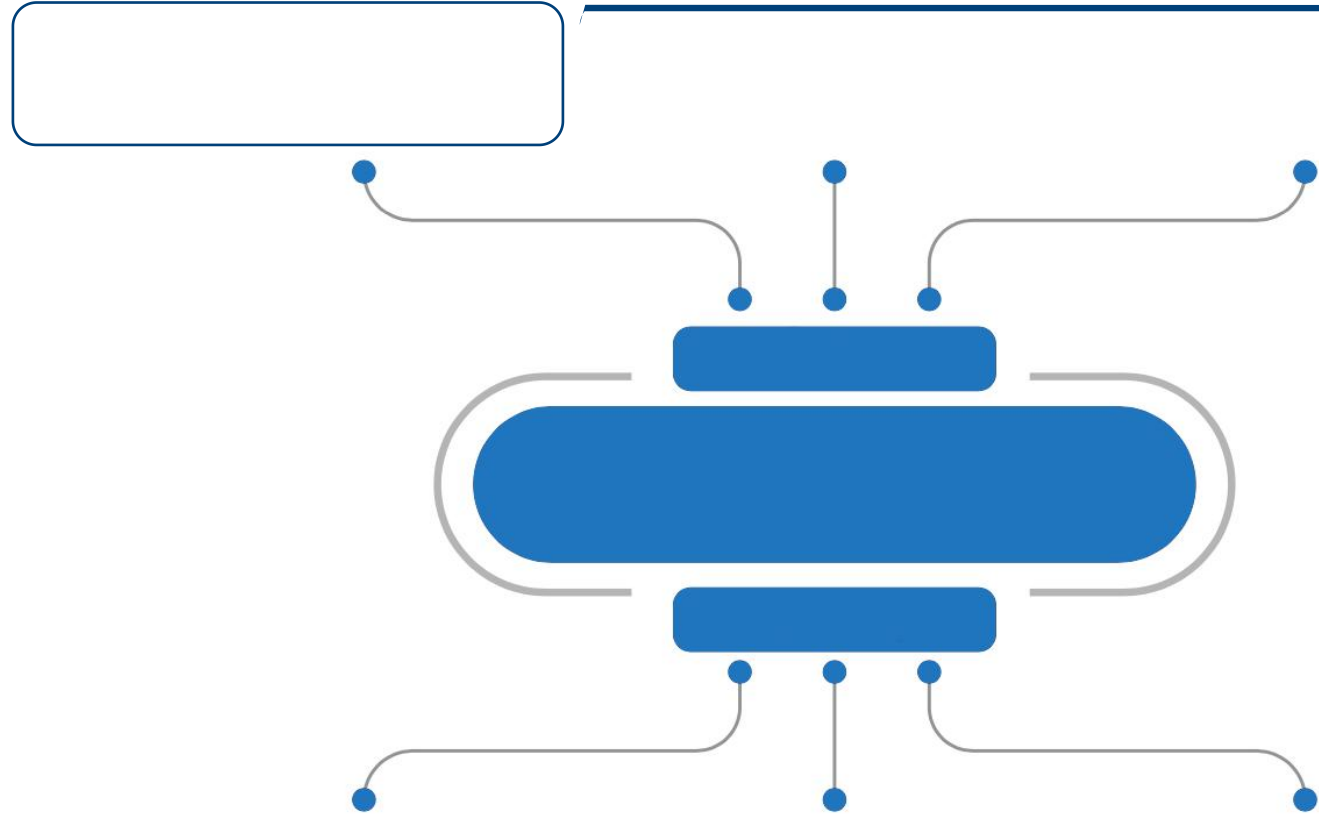







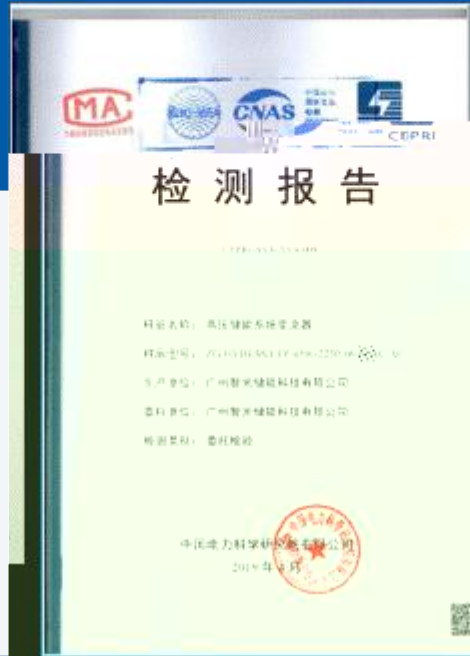

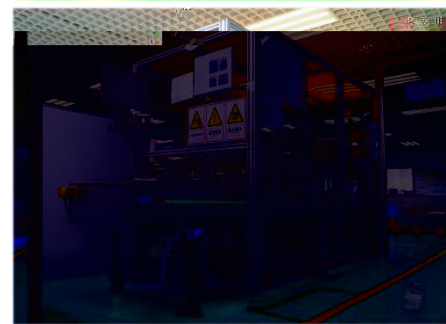
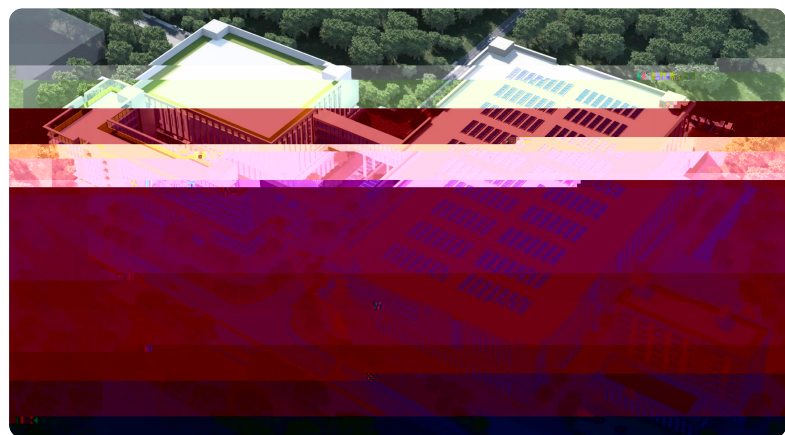
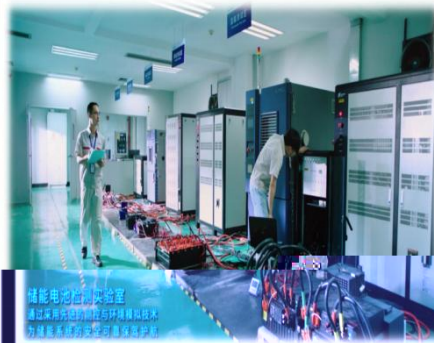
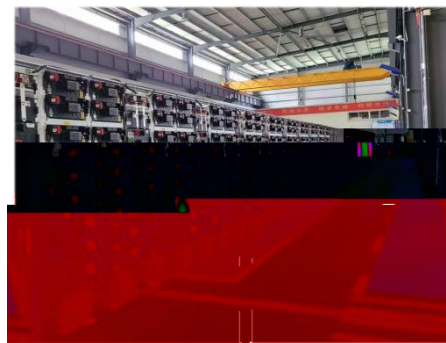



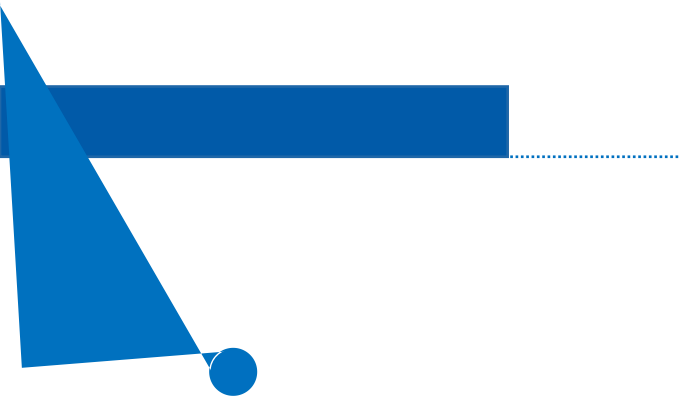



1

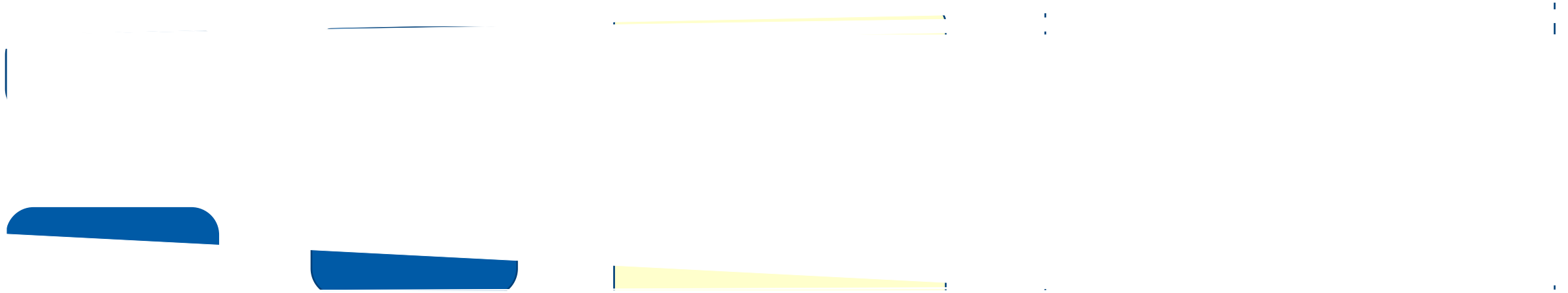



-
-







移动式储能测试平台

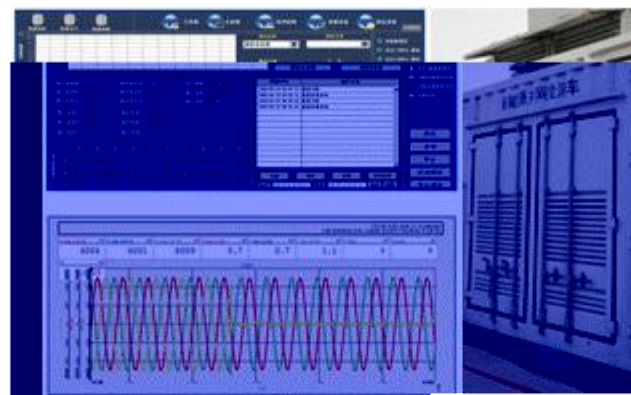

6/10kV/6MVA 储能测试平台

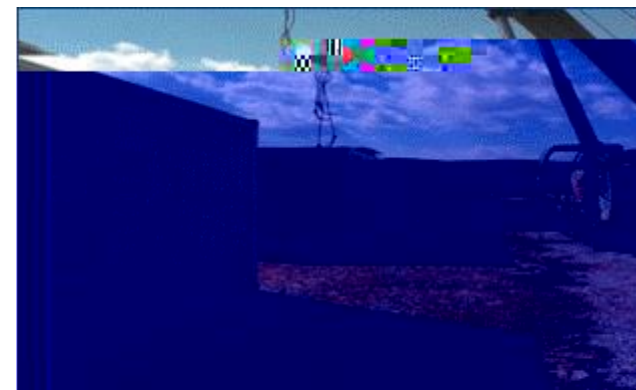

35kV/4MVA新能源测试平台





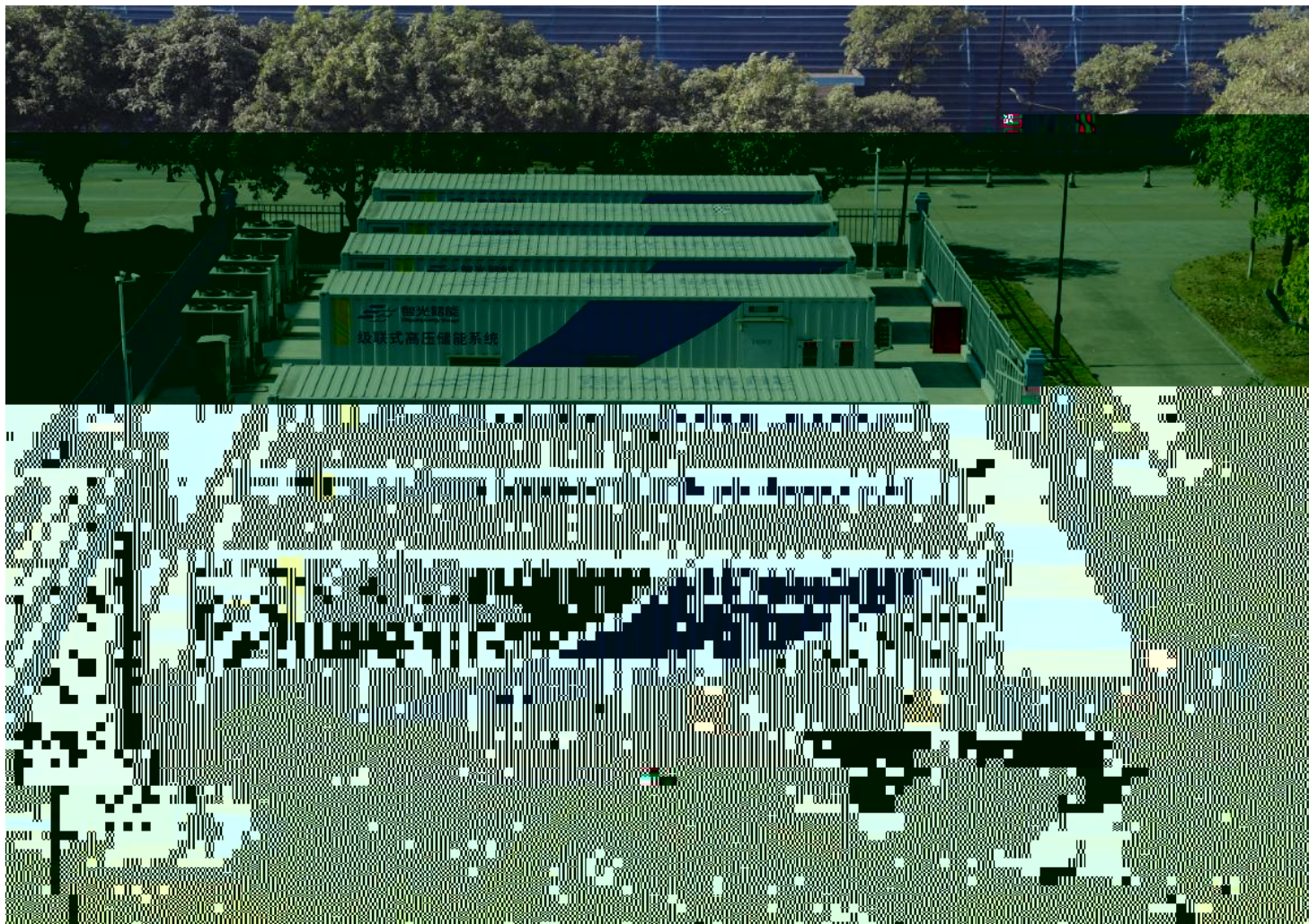

#1机组高压母线

#2机组高压母线

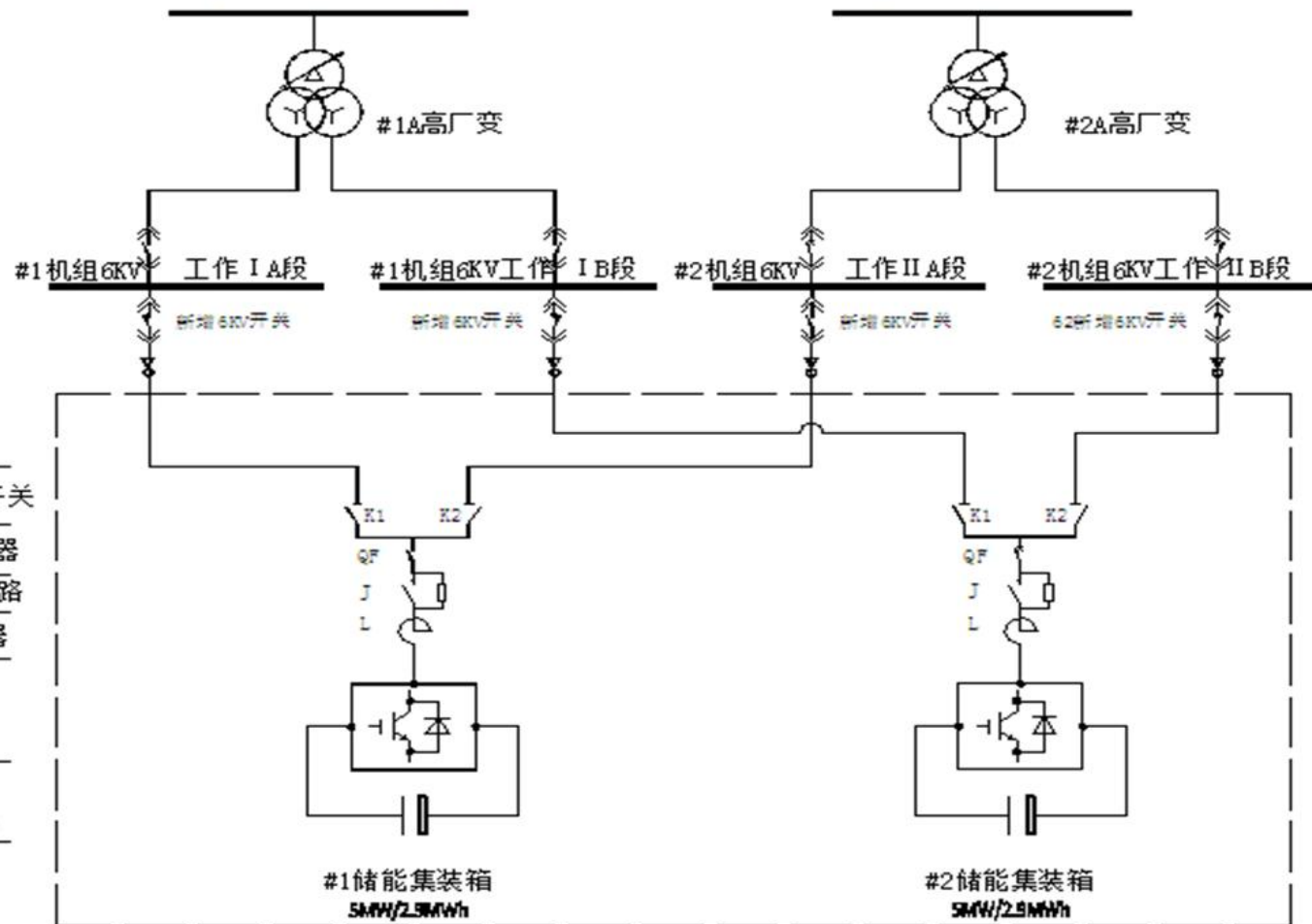

输入开关

断路器

充电回路

电抗器

FCS

电池

#1储能集装箱
5MWh/2.5MWh

#2储能集装箱
5MWh/2.5MWh



